

# **OPERATING MANUAL**

## **MOUNTED KOMPAKTOMAT**

### **K250N | K300N**

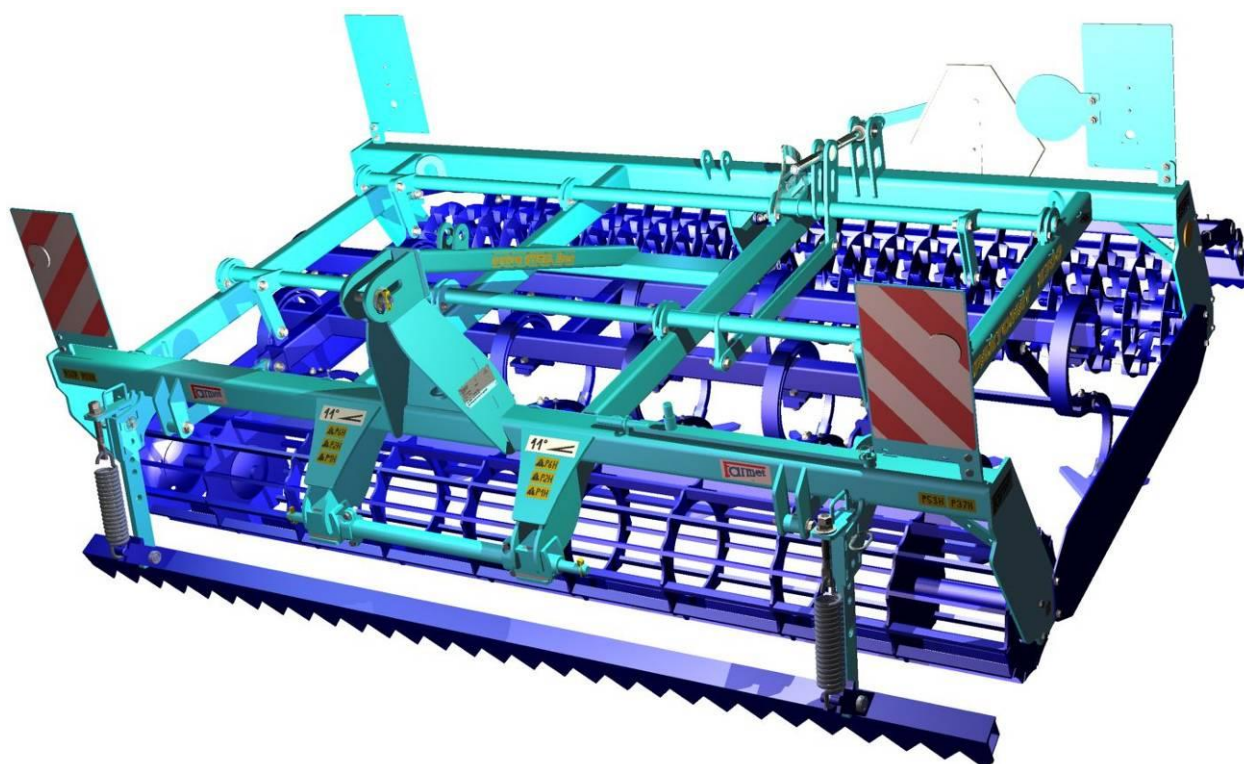

**Edition: 12 | effective from: 1. 1. 2019**

Dear Customer,



The Mounted **KOMPAKTOMATS** are quality products by Farmet a.s., Česká Skalice, Czech Republic. The advantages of your machine can be fully utilized after studying this Operating manual.

The serial number of the machine is stamped on the production label and mentioned in the Operating manual. This serial number should be mentioned for reference when ordering spare parts. The production label is located on the side of the frame.

All spare parts should be ordered according to the official **Spare Part Catalogue** issued by Farmet a.s., Česká Skalice, Czech Republic.

**The Use of Your machine**

The Kompaktomat is designed for soil preparation before sowing and for follow-up operations after ploughing or stubble ploughing. The field treated with this machine has the ideal sowing bed. Use the machine with the tractors the output of which is **55-75 kW**. For the optimum soil cultivation keep the working speed between **10 to 12 km p.h.**

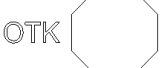
  		Farmet a.s. Jřfinková 276 Česká Skalice	
TYPE/VERSION	KOMPAKTOMAT	K 300 N	
CERTIFICATION NUMBER		N-677-03-05	
PRODUCTION YEAR/NUMBER		[ ]	
MAX. PERMISSIBLE WEIGHT		1510	kg
MAX. PERMISSIBLE WEIGHT ON THE AXLE		-	kg

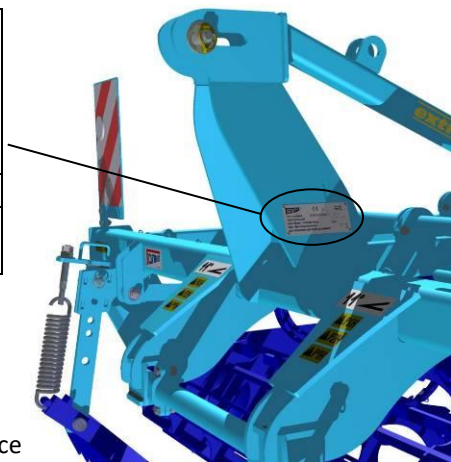

**KOMPAKTOMAT Specifications**

The machine standardly consists of the following parts:

- three-point mounting for attaching to a TPS pulling appliance
- supporting machine frames
- the machine is standardly equipped with front and rear safety signs with oblique red and white hatching and with reflectors and a reflective plate with the rear licence plate according to EEC No. 69.

PARAMETERS		K 250 N	K 300 N
Working + transport width (mm)		2580	2980
Working depth (mm)		0 – 100	
Number of shares <b>ARROW/CHISEL</b> (pcs)		11 / 26	13 / 30
Working capacity (Hectares per Hour)		2 - 3	2,2 – 3,2
Towing Vehicle (kW)		55 - 65	60 – 75
Working Speed (km per Hour)		10-12	
Max. Transport Speed (km per Hour)		20	
Maximum Slope Accessibility (°)		11	
Total Length (mm)		2560	
Weight (kg)		1155	1510
Requirement for the tractor TPS	Distance of the bottom suspension hinges (at the axes of the hinges)	870+/- 1,5 mm	
	∅ holes of the bottom suspension joints for the suspension hinge pins of the machine	∅29 mm	
	∅ holes of the upper suspension joint for the suspension hinge pin of the machine	∅26 mm	

- CRITICAL PARAMETERS	Page 4
SAFETY WARNING	Page 4
- A. GENERAL INSTRUCTIONS FOR USE	Page 4
PROTECTIVE EQUIPMENT	Page 5
- B. TRANSPORTING THE MACHINE BY VEHICLES	Page 5
- C. MANIPULATING THE MACHINE BY LIFTING EQUIPMENT	Page 6
- D. WORK SAFETY LABELS	Page 6-8
- 1. DESCRIPTION OF THE MACHINE	Page 9
1.1 WORKING PARTS OF THE MACHINE	Page 9-12
- 2. ASSEMBLY OF THE MACHINE AT THE CUSTOMER'S SITE	Page 12
- 3. PUTTING INTO OPERATION	Page 12
3.1 AGGREGATION TO THE TRACTOR	Page 13
- 4. TRANSPORTING THE MACHINE ON GROUND COMMUNICATIONS	Page 14
- 5. ADJUSTING THE WORKING PARTS OF THE MACHINE	Page 15
5.1 ADJUSTING THE SPRING-MOUNTED FRONT LEVELLER	Page 15
5.2 ADJUSTING THE DEPTH OF THE SHARE SECTION	Page 16
5.3 ADJUSTING THE LEVELLER HEIGHT BEHIND SHARES	Page 17
- 6. MAINTENANCE AND REPAIRS	Page 18
6.1 LUBRICATION PLAN FOR THE MACHINE	Page 18
6.2 REPLACEMENT OF WORN-AND-TORN SHARES	Page 19
- 7. EXTRA MACHINE EQUIPMENT	Page 20
7.1 HYDRAULIC LEVELLERS	Page 20
7.2 HYDRAULIC DEPTH	Page 20
7.3 TRAIL CULTIVATORS	Page 20
- 8. MACHINE DISPOSAL AFTER ITS SERVICE LIFE	Page 21
- 9. SERVICES AND WARRANTY CONDITIONS	Page 21
- CE CERTIFICATE OF CONFORMITY	Page 22

## CRITICAL PARAMETERS OF THE MACHINE

- The machine is to be used for presowing preparation of soil after ploughing or stubble breaking with working depth from 0 mm to 100 mm for soil cultivation in agriculture. Other uses exceeding the determined purpose is forbidden.
- The machine is operated by one person – the tractor driver.
- The operator must not use the machine for other purposes, particularly:
  - For transporting people and animals on the construction of the machine.
  - For transporting load on the construction of the machine.
  - Aggregation of the machine with other tractive equipment than stated in Chapter “3.1/p.13”.

## SAFETY WARNING



This warning symbol warns against an imminent dangerous situation that could lead to death or serious injury.







This warning symbol warns against a dangerous situation that could lead to death or serious injury.



This warning symbol warns against a situation that could lead to a small or minor injury. It also points out dangerous tasks related to the activity that could lead to an injury.

## A. GENERAL INSTRUCTIONS FOR USE

- A.1** <sup>(x)</sup> The machine is produced in compliance with the latest technological conditions and approved safety regulations. However, the use of the machine may still cause injuries to the user or third persons or damage to the machine or occurrence of other material damages.
- A.2** <sup>(xx)</sup> Use the machine only in a technically unexceptionable condition, in compliance with its purpose, with awareness of potential risks and observance of safety instructions stated in this manual!  
The Manufacturer is not liable for damages caused by the use of the machine that is in contradiction with the limit parameters of the machine and with the instructions for the use of the machine (Chapter A and 5).  
The User bears the risk.  
Immediately eliminate all defects that could have a negative impact on safety!
- A.3** <sup>(7)</sup> The machine may only be operated by a person authorized by the owner under the following conditions:
- <sup>(8)</sup> He or she must have a valid driving licence in the relevant category,
  - <sup>(9)</sup> He or she must be verifiably informed on the safety rules of working with the machine and must have command of the operation of the machine in practice,
  - <sup>(10)</sup> The machine must not be operated by a minor (minors),
  - <sup>(11)</sup> He or she must understand the meaning of warning symbols placed on the machine. Respecting the symbols is important for a safe and reliable operation of the machine.
- A.4** <sup>(12)</sup> Maintenance and service repairs may only be performed by a person:
- <sup>(13)</sup> Authorized by the owner,
  - <sup>(14)</sup> Trained in an engineering field with the knowledge of repairs of similar machinery,
  - <sup>(15)</sup> Verifiably informed on the safety rules of working with the machine,
  - <sup>(16)</sup> With a driving licence in the relevant category for repairs of the machine attached to a tractor.

- A.5** <sup>(17)</sup> The operator of the machine must ensure safety of other people during the work with the machine and its transportation.
- A.6** <sup>(18)</sup> During machine work in the field or during transport, the operator must control the machine from the tractor's cabin.
-  **A.7** <sup>(19)</sup> The operator may only enter the construction of the machine when the machine is off and secured against movement only in order to:
- <sup>(20)</sup> adjust the working parts of the machine,
  - <sup>(21)</sup> repair and maintain the machine.
-  **A.8** <sup>(xxx)</sup> When climbing onto the machine, do not step on the tyres of the rolls or other revolving parts as they may roll over and you can seriously hurt yourself if you fall down.
-  **A.9** <sup>(22)</sup> Any changes or adjustments of the machine may only be performed with a written consent of the producer. The producer is not responsible for any potential damages occurred as a result of non-compliance with this instruction. The machine must always be equipped with the prescribed accessories, equipment and gear including the safety labels. All warning and safety signs must be always legible and at their positions. They must be replaced if damaged or lost without delay.
- A.10** <sup>(23)</sup> The operating manual and the requirements of the safety at work must be always available to the operator.
-  **A.11** <sup>(24)</sup> When operating the machine, the operator must not consume alcohol, medicine, narcotic and hallucinogenic substances that reduce attention and coordination abilities. If the operator has to take medicine prescribed by the physician or if he or she uses over the counter medicine, he or she must be informed by the physician whether he or she is able to reliably and safely operate the machine under these circumstances.

## **PROTECTIVE EQUIPMENT**

For the operation and maintenance use:

- Tight clothes
- Protective gloves and goggles for protection against dust and sharp parts of the machine

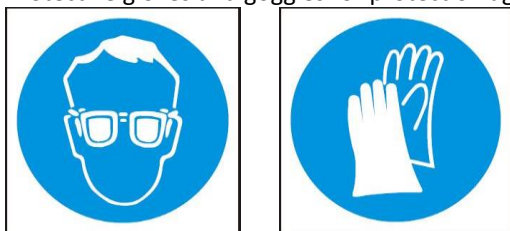



## **B. TRANSPORTING THE MACHINE BY VEHICLES**

- B.1** <sup>(1)</sup> The vehicle intended for the transportation of the machine must have at least the same bearing capacity as the weight of the transported machine is. The total weight of the machine is stated on the production label.
- B.2** <sup>(2)</sup> The dimensions of the transported machine including the vehicle must comply with valid regulations for traffic on ground communications (decrees, acts).
-  **B.3** <sup>(3)</sup> The transported machine must be always attached to the vehicle so that it cannot be released during transportation.

**B.4** <sup>(4)</sup> The carrier is responsible for damages caused by the release of incorrectly or insufficiently attached machine to the vehicle.

## **C. MANIPULATING THE MACHINE BY LIFTING EQUIPMENT**

**C.1** <sup>(1)</sup> The lifting equipment and binding instruments intended for manipulation with the machine must have at least the same bearing capacity as the weight of the manipulated machine is.

 **C.2** <sup>(2)</sup> The machine may only be attached for manipulation in designated places marked by stick-on labels showing a “chain”. 

**C.3** <sup>(3)</sup> When attached (suspended) in designated places, it is not allowed to move in the area of potential reach of the manipulated machine.

## **D. WORK SAFETY LABELS**

Warning safety labels are used for the protection of the operator.

### **THE FOLLOWING APPLIES GENERALLY:**



**D.1** Strictly observe the warning safety labels.



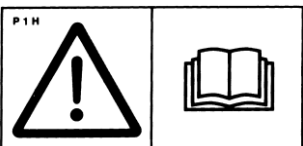
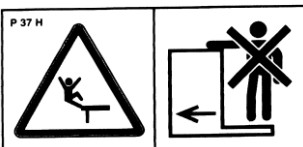

**D.2** All safety instructions also apply to other users.

**D.3** If the aforementioned “SAFETY LABEL” located on the machine is damaged or destroyed, **THE OPERATOR MUST REPLACE IT WITH A NEW ONE!!!**

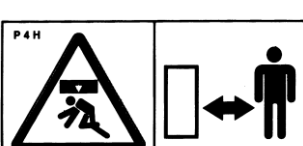
The position, appearance and exact meaning of work safety labels on the machine are given in the following charts (Chart 1/p.6-7) and the pictures (Picture 1/p.8).

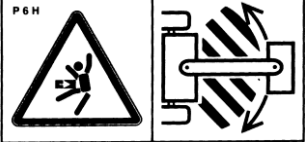
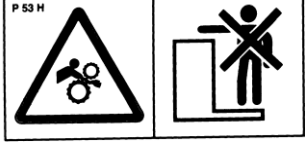
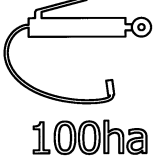
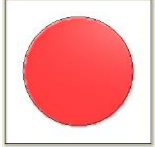
Chart 1 – Stick-on warning safety labels placed on the machine

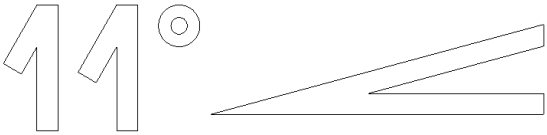
<b>LABEL IMAGE</b>	<b>LABEL SPECIFICATION</b>	<b>LABEL TEXT</b>
	<b>P 1 H</b>	Read carefully the operating manual before manipulation with the machine. Observe the instructions and safety rules when operating the machine.
	<b>P 37 H</b>	Driving the machine and transportation on its construction is strictly forbidden.
	<b>P 2 H</b>	When connecting and disconnecting, do not enter the area between the tractor and the machine. Do not enter that area unless the tractor and the machine are not moving and the engine is off.
	<b>P 4 H</b>	Keep away from the reach of the hoisted machine unless resting on the ground.

	<p><b>P 6 H</b></p>	<p>Keep away from the reach of the tractor + machine if the tractor engine is running or the set moving.</p>	
	<p><b>P 53 H</b></p>	<p>Do not approach the rotary parts of the machine unless they are standing still, i.e. they are not rotating.</p>	
			<p>Lubrication places on the machine</p>
		<p>Slope accessibility of the machine</p>	
		<p>Places safe for suspension of the machine by a lifting device</p>	

Picture 1 - Warning labels on the machine

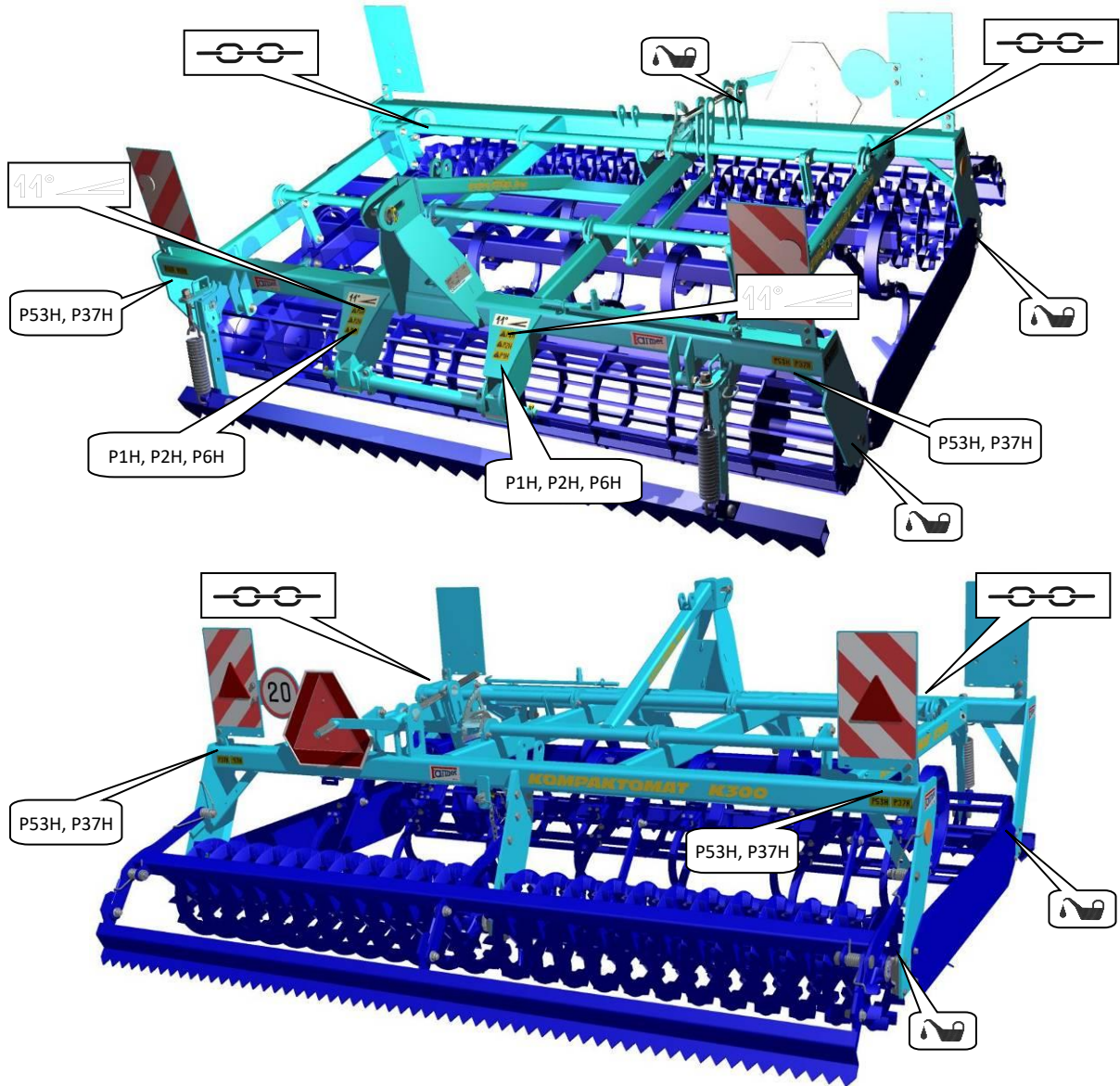



## 1. MACHINE DESCRIPTION

The machine is structurally designed as mounted by the rear three-point suspension of the tractor. The basic version of the machine consists of a supporting frame with a three-point suspension of Category 2 and from the working parts of the machine.

### 1.1 WORKING PARTS OF THE MACHINE

#### TRACK CULTIVATORS WITH CHISEL SHARE – Attention! Not included in the standard equipment of the machine

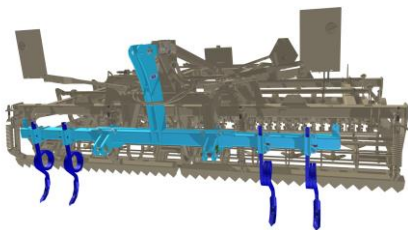

##### CC

Automatically released tractor track cultivator with a chisel share. Suitable for all types of soil. Possibility of mechanical depth setting up to 80mm. Possibility of setting the position directly behind the tractor up to the tractor width of 4000mm. Possibility to change the number of cultivators from 1 to 4 pieces behind a wheel. Designed as an inserted piece between the tractor and Kompaktomat. Attention! The application of track cultivators moves the center of gravity further away from the tractor!

#### FRONT LEVELLERS

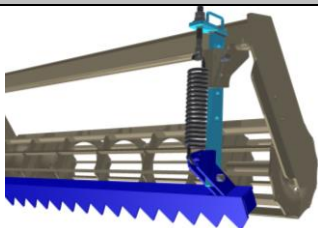

##### FL – Front Fixed Serrated Levelling Bar

Included in the equipment of the STANDARD MACHINE VERSION.

Automatically released levelling bar with a serrated section. Massive construction for precise levelling of coarse furrows.

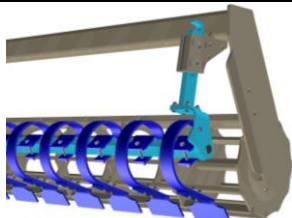

##### FB – Front Levelling Bar with Flexible Segments

Automatically released levelling bar with separate flexible segments. Better clod crumbling.

#### FRONT WORKING ROLLERS

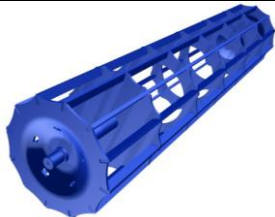

##### BR - Bar Roller - Ø40 cm - 60 kg/m

Included in the equipment of the STANDARD MACHINE VERSION, as a front roller.

High-quality clod crumbling. Not suitable for humid conditions.

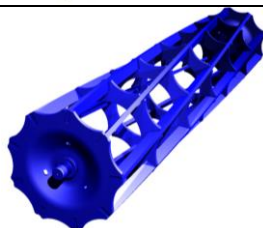

##### SB - Spiral Bar Roller - Ø40 cm - 60 kg/m

Quality clod crumbling. Suitable for humid conditions.

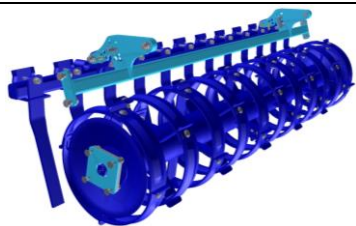

**RR - Ring Roller Ø40 cm - 115 kg/m**

Quality work in all types of soil, good depth guiding, suitable for more humid soils.

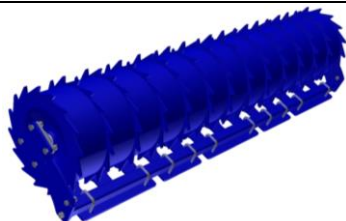

**SR - Segmented Roller Ø40 cm - 115 kg/m**

Excellent work in medium and heavy hard soils, good clod crumbling, good depth guiding. Not suitable for heavily flinty and silt soils.

## SHARE SECTIONS

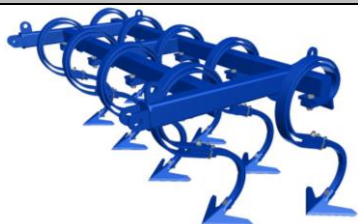

**AL – Section**

Included in the equipment of the STANDARD MACHINE VERSION.

The share section is equipped with sweeps with the width of 25 cm in two rows. Each sweep is protected by a leaf spring. This section is suitable for lighter soil conditions without plant residues. There is a leveller behind the sweeps.



**CF – Section**

The share section is equipped with slim chisels with the width of 7 cm in four rows. The section is suitable for processing soil in spring when it is not suitable to pull wet soil out to the surface, or for heavy soils. There is **no** leveller behind the chisels.

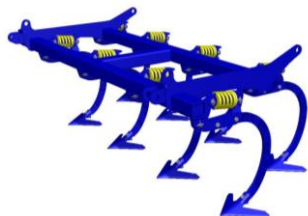

**AP – Section**

A universal share section is equipped with sweeps with the width of 25 cm in two rows. The sweeps are mounted to frames with geometry improving the permeability of plant residues. Therefore, this section is suitable for land with a higher occurrence of crushed plant residues as well as for heavy soils. There is a leveller behind the sweeps.

	AL	CF	AP
Number of rows of shares (pieces) / Row spacing (mm)	2 / 400	4 / 240	2 / 490
Leveller behind shares	●●●●	●●●●	●●●●
All-area processing	●●●●	●●●○	●●●●
Suitable for light soils	●●●●	●●●●	●●●●
Suitable for medium soils	●●●○	●●●○	●●●●
Suitable for heavy soils	●●●○	●●●○	●●●●
Suitable for rocky soils	●●●○	●●●○	●●●●
Suitable for wet soils	●●○○	●●●●	●●○○
Resistance to clogging	●●○○	●●●○	●●●○

● – MAX / ○ - MIN

## LEVELLING BARS BEHIND SHARES

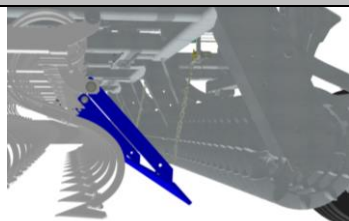

**LEVELLING BAR BEHIND SHARES**

Included in the equipment of the STANDARD MACHINE VERSION.

The levelling bar is applied behind the share sections with sweeps and chisels, i.e. A-section, B-section or C-section. The bar is used for levelling the loosened soil in front of the rear roller.

## REAR WORKING ROLLERS

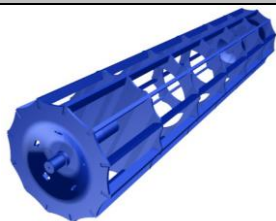

**BR - Bar Roller - Ø40 cm - 60 kg/m**

Included in the equipment of the STANDARD MACHINE VERSION, as a front roller.

High-quality clod crumbling. Not suitable for humid conditions.

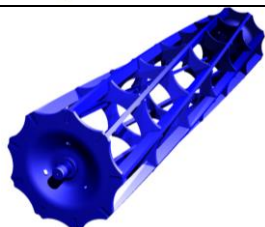

**SB - Spiral Bar Roller - Ø40 cm - 60 kg/m**

Quality clod crumbling. Suitable for humid conditions.



**CR - Cross-kill Roller - Ø40 cm - 170 kg/m**

Included in the equipment of the STANDARD MACHINE VERSION.

Excellent work in light, medium and heavy soils, quality compaction and clod crumbling.



**DCR - Double-row Cross-kill Roller - Ø40 cm / Ø40 cm - 175 kg/m**

Excellent work in light, medium and heavy soils, quality compaction and clod crumbling.

Attention! The application of track cultivators moves the center of gravity further away from the tractor!

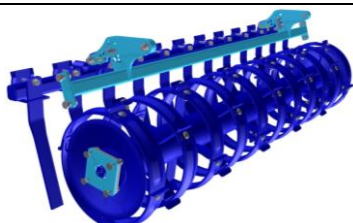

**RR - Ring Roller Ø40 cm - 115 kg/m**

Quality work in all types of soil, good depth guiding, suitable for more humid soils.

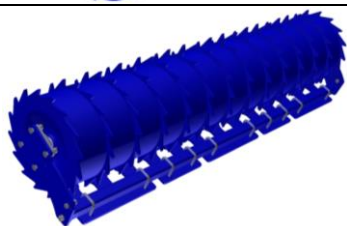

**SR - Segmented Roller Ø40 cm - 115 kg/m**

Excellent work in medium and heavy hard soils, good clod crumbling, good depth guiding. Not suitable for heavily flinty and silt soils.

	BR	SB	CR	DCR	RR	SR
Crumbling	●●●○	●●●○	●●●●	●●●●	●●○○	●●○○
Compacting	●●●○	●●●○	●●●●	●●●●	●●●●	●●●○
Depth guiding	●●●●	●●●●	●○○○	●●○○	●●●●	●●●●
Resistance to clogging	●●○○	●●●○	●●●○	●●●●	●●●●	●●●○
Suitable for rocky soils	●●●○	●●●○	●●○○	●○○○	●●●○	●●●○
Suitable for wet soils	●○○○	●●●○	●●○○	●●●○	●●●●	●●●○
Heavy soils	●●○○	●●○○	●●●○	●●●○	●●●○	●●●○
Medium soils	●●●○	●●●○	●●●●	●●●●	●●●○	●●●○
Light soils	●●●●	●●●●	●●●●	●●●●	●●○○	●●●○

● - MAX / ○ - MIN

## FINISHING OPERATIONS

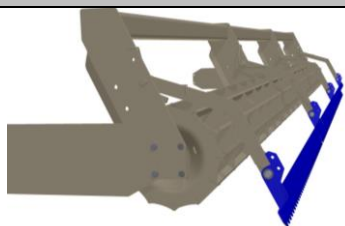

### REAR FINISHING LEVELLING BAR

Included in the equipment of the STANDARD MACHINE VERSION.

The levelling bar behind the rear roller levels and evenly spreads the loosened soil.

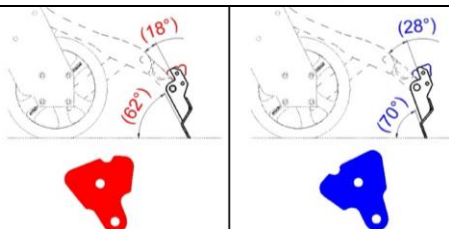

### Levelling Bar Stops

Included in the equipment of the STANDARD MACHINE VERSION.

-Pivoting stops allowing a more aggressive setting of the rear levelling bar.

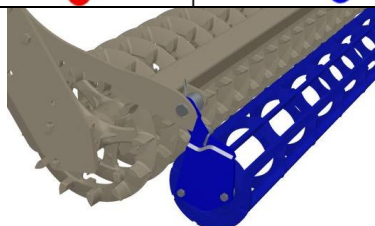

### REAR FINISHING ROLLER (diameter 220mm)

-Active crumbling of remaining clods after the rear roller. May be used after all types of rear rollers.

## 2. ASSEMBLY OF THE MACHINE AT THE CUSTOMER'S SITE



- The operator must execute the assembly according to the producer's instructions, if possible in cooperation with a professional service technician determined by the producer.
- The operator must execute a functional test of all assembled parts after the completion of the assembly of the machine.
- The operator must ensure that the manipulation with the machine by lifting equipment corresponds with Chapter "C".

## 3. PUTTING INTO OPERATION



- Before you take over the machine, test and check it for any damages incurred during transportation and check that all parts included in the delivery note have been delivered.
- Before you put the machine into operation, read the operating manual carefully.
- Learn about the control elements of the machine and its overall function before the first use.
- When working with the machine, observe the instructions in the manual as well as generally valid rules for the safety at work, protection of health, fire and traffic safety and protection of environment.
- The operator must check the machine before every use (putting into operation) for aspects in the field of completeness, safety at work, work hygiene, fire safety, traffic safety and protection of environment.
- **IF THE MACHINE SHOWS SIGNS OF DAMAGE, IT MUST NOT BE PUT INTO OPERATION!!**
- Execute aggregation of the machine with the tractor on an even and compact surface.
- When working on slopes, observe the lowest slope accessibility of the whole set **TRACTOR – MACHINE**.
- Before turning on the engine of the tractor, check that there are no people or animals in the working area of the set and press the warning sound signal.
- The operator is responsible for safety and for all damages caused by the operation of the tractor and the attached machine.
- The operator must observe technical and safety regulations of the machine determined by the producer when working with the machine.

- The operator must raise the machine when turning at the plough turning end, i.e. the working parts must not be in the ground.
- The operator must observe the prescribed working depths and speeds set in the operating manual when working with the machine.
- The operator must lower the machine to the ground and secure the set against movement before leaving the cabin of the tractor.

### 3.1 AGGREGATION TO THE TRACTOR

- Always aggregate the machine on an even and reinforced surface.
- The operator must observe all generally valid regulations for the safety at work, protection of health, fire safety and protection of environment.
- The operator may only attach the machine to a tractor which is equipped with a rear three-point mounting and a functional undamaged hydraulic system.
- The operator must secure the machine against movement prior to the aggregation to the tractor, especially with tractors that are not equipped with a quick hitch. The operator must arrange a cooperation of another, verifiably trained person for the aggregation of the machine with a tractor that is not equipped with a quick hitch. The assistant must not move in the area of the hitch when the tractor moves towards the machine. The assistant may only enter the rear mounting of the tractor when the tractor is secured against movement. The operator may execute aggregation from the tractor driver's position in case of a tractor with a quick hitch.
- After the aggregation of the machine with the tractor, the length of the tractor TPS adjuster must be set. The machine must be resting on the working rollers. For work in the field, set the length of the adjuster so that the bolt is about half way through the oval opening (Picture 2). The adjuster will ensure a trouble-free operation of the machine and allow terrain tracing. When the adjuster is too short or too long, the rollers of the machine will be overloaded during the field work. This causes damage to the rollers and failure of the machine to fully trace the terrain.

Picture 2- aggregation of the machine with the tractor

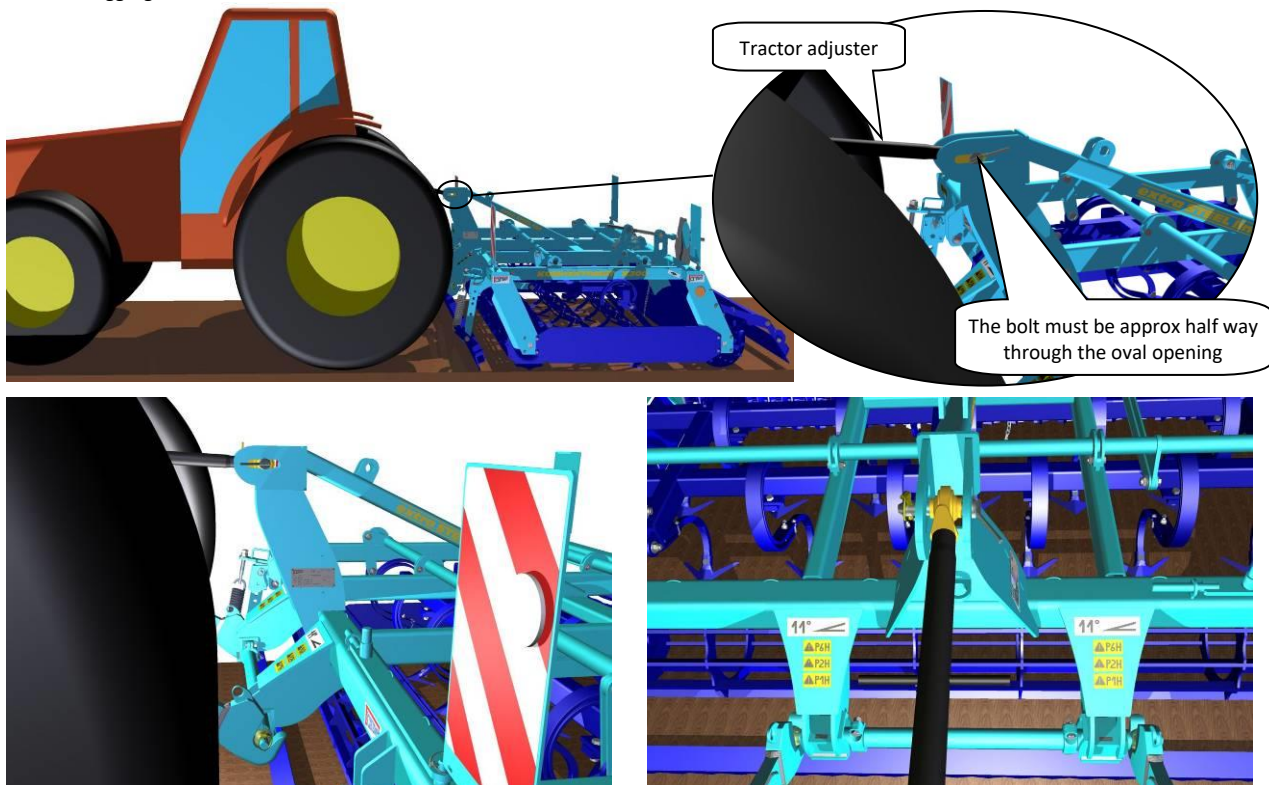

## 4. TRANSPORTING THE MACHINE ON GROUND COMMUNICATIONS

- The operator shall observe the lowest indicated transport speed during transport and the lowest indicated slope accessibility of the entire set.
- The operator must drive with increased caution when transporting the machine on ground communications due to the transport dimensions of the machine.
- When transporting on public roads the machine should be provided with a functional set of warning lights that must be on. If possible, the highest point of the set (usually the tractor roof) should be provided with a yellow flashing beacon. Moreover, the machine should be provided with the "maximum-speed" sign, with red-and-white-hatched boards at the machine contours and with rear reflectors and reflecting board according to the respective regulations.
- Using international highways and 1st-class highways for transportation of the machine towed by a tractor is prohibited. These may be only crossed.
- The machine should not be transported at poor visibility.
- The operator must observe valid regulations for the operation on ground communications (acts, decrees) after connecting the machine to the tractor due to the changes in the load of axles. The driving properties of the set also change in relation to the character of the terrain; therefore adapt the method of driving to these conditions.
- If requested, the operator shall submit the technical certificate of the machine according to the valid regulations for the operation on ground communications (only in the Czech Republic).
- When transporting the machine on public roads, all the respective traffic rules and traffic signs should be observed.
- When reversing with the attached machine, the operator shall ensure a sufficient view from his or her position as the driver of the tractor. If the view is not sufficient, the operator shall call a qualified and instructed person.

Picture 3-Transport position for the machine



## 5. ADJUSTING THE WORKING PARTS OF THE MACHINE

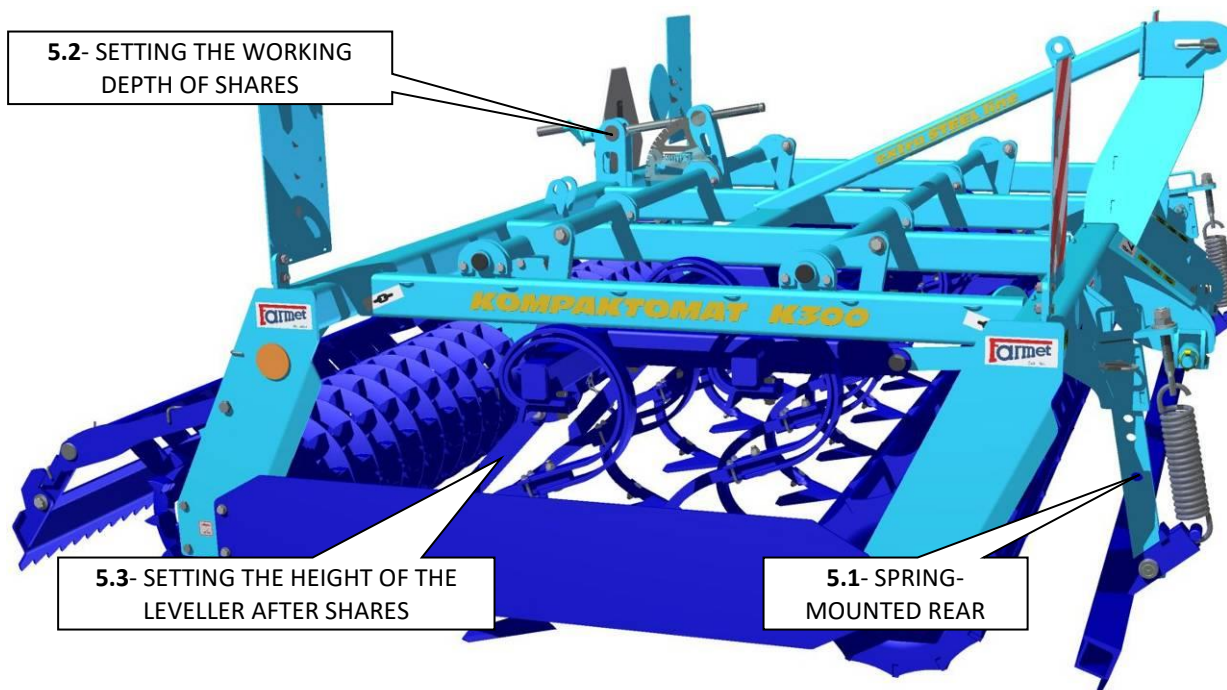

### 5.1 ADJUSTING THE SPRING-MOUNTED FRONT LEVELLER

- The height of the front leveller may be adjusted as well as the spring force of the leveller.
- Perform the adjustment of front levellers when the machine is standing on the working sections.

**5.1.1** Adjust the height of the front leveller by moving the lever in the holder and securing the position by a peg. The height of the front leveller is adjusted in relation to the size of clods and curvature of the field so that the leveller is about 3 to 5 cm above the level of the working rollers when the machine is lowered to the working rollers. When needed, the leveller may be set higher or lower.

*It is possible to equip the machine with the optional hydraulic control for the leveller height from the tractor driver's place.*

**5.1.2** The spring-mounting of the front leveller is secured by a tractive spring. The spring is preset to  $L=345-350\text{mm}$ , the maximum prestressing is  $L_{\text{max}}=370\text{mm}$ . Its strain capacity may be changed by a tension screw. The prestress of the spring is selected on the basis of the field type (according to the size of clods). The larger the clods are, the larger the prestress is necessary.

Picture 4- height leveller adjustment

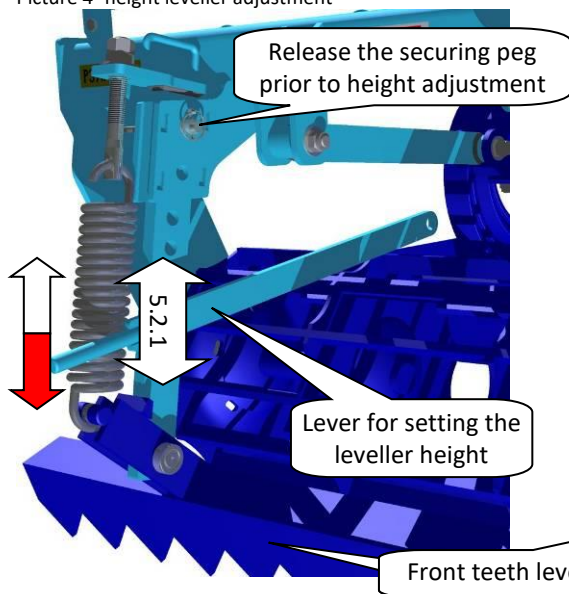

Picture 5- adjustment of the front leveller spring

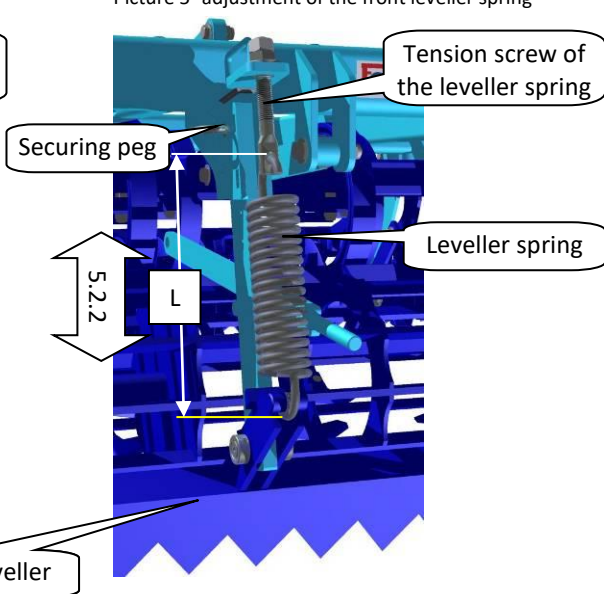

## 5.2 ADJUSTING THE DEPTH OF THE SHARE SECTION

- The soil processing depth is selected according to the type of crop you want to grow. Approximate values of processing depth are provided in Chart 2.
- Adjust the depth of the shares when the machine is unfolded into the working position and standing still. The machine must be raised in the shoulders of the tractor so that there is a gap of up to 50 mm between the solid ground and working sections.
- **Apply heightened caution when adjusting the depth of the shares due to the potential rolling of the working roller.**
- The working depth of the shares is adjusted by turning the handle with the trapezoid thread. The handle is located on each frame of the machine. The depth is set by turning the mounting handle. For transparent setting of the depth, there are pointers with depth gauges near the handles.

*It is possible to equip the machine with the optional hydraulic control for the ploughshare height from the tractor driver's place.*

Picture 6 – Setting the processing depth

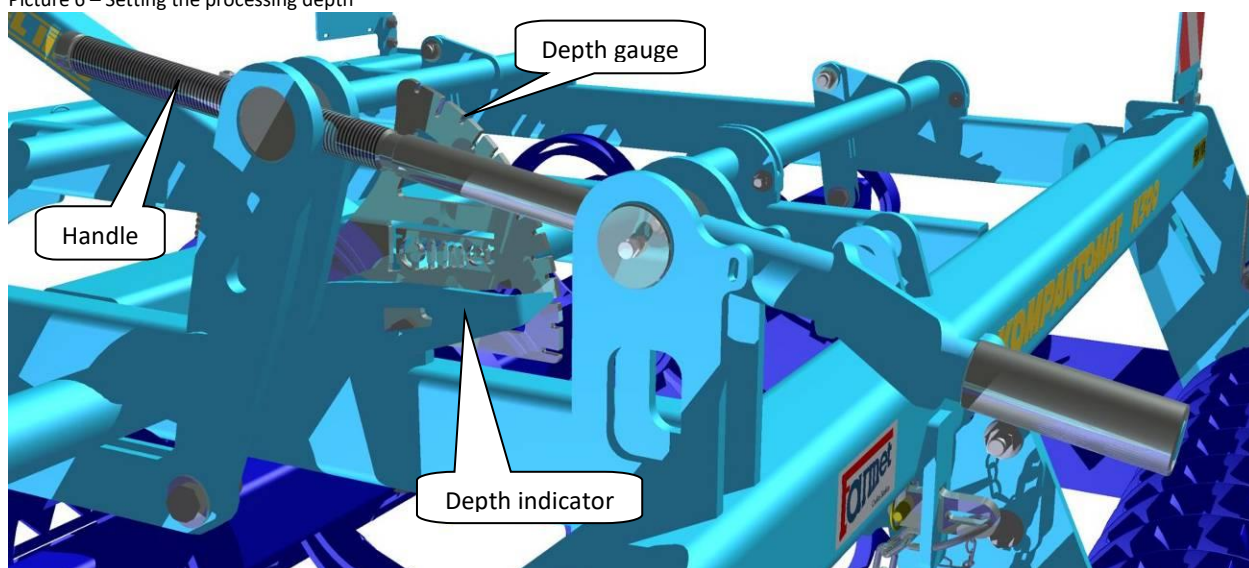



Picture 7 – Setting the processing depth

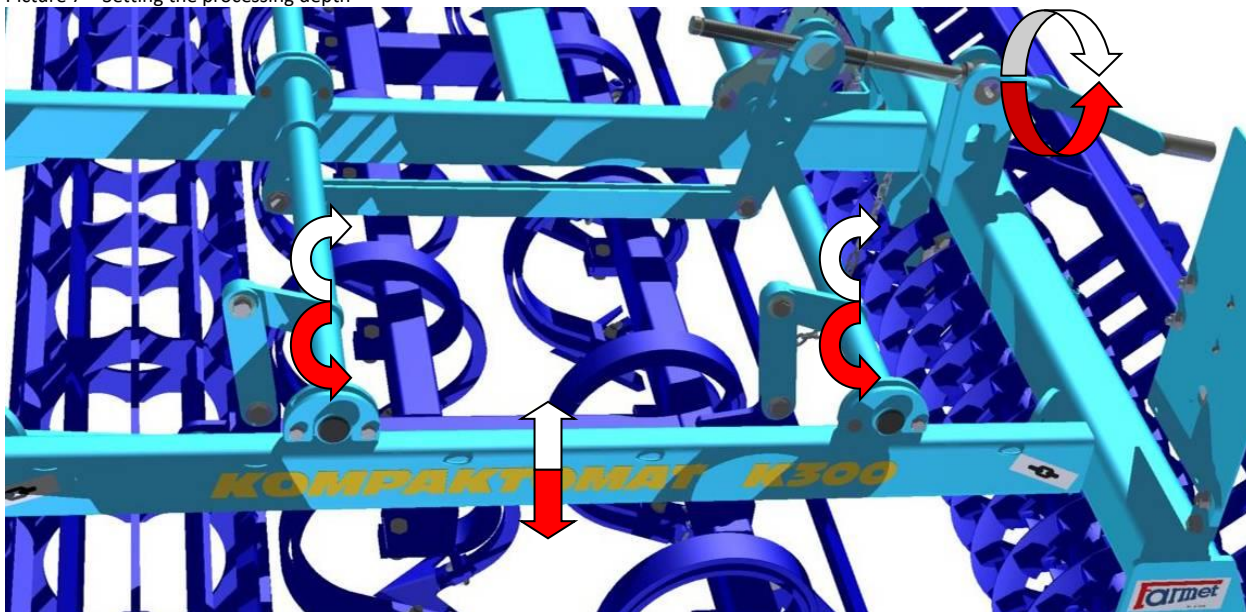

Chart 2 – Approximate processing depth acc. to crops

CROP	DEPTH
Beet	2-3 cm
Rape	3-5 cm
Wheat, barley, oats	5-8 cm

### 5.3 ADJUSTING THE LEVELLER HEIGHT BEHIND SHARES

- The leveller behind shares is used for levelling the cultivated soil after the rear row of arrow shares before the rear roller.
- The height of the leveller behind shares is adjusted by the chain between the leveller and the bearing frame. The chain is screwed to the leveller and it is passed through an eye in the bearing frame and secured.
- The height of the leveller is set in relation to the working depth of the shares. The deeper the processing is, the higher the leveller needs to go. Set the leveller height "V" above solid ground between 60 – 100 mm.
- **Perform the adjustment of the height of the levellers when the machine is unfolded in the working position and standing still. The machine must rest on the working sections.**



Picture 8 – Adjusting the leveller behind shares

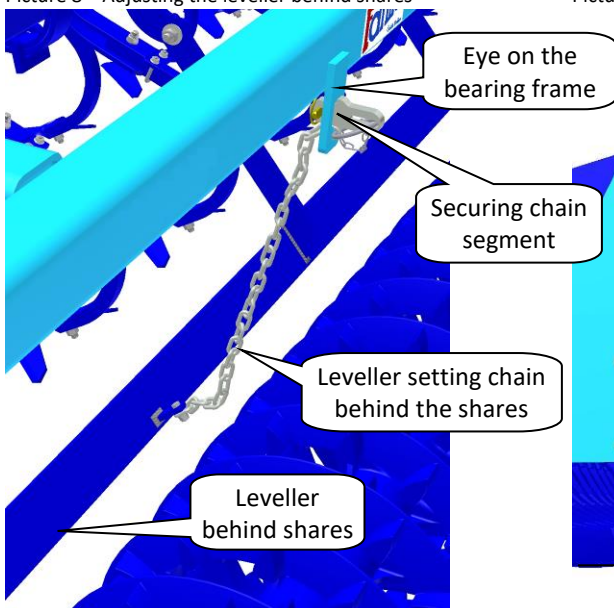

Picture 9 – Height of the leveller behind share

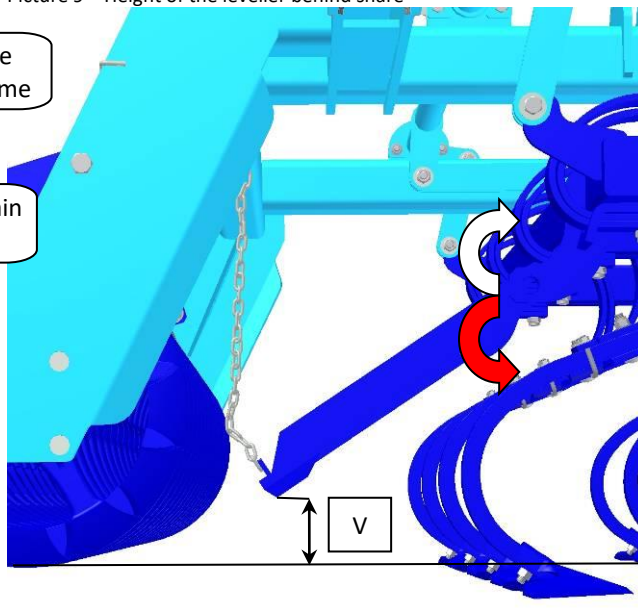

## 6. MAINTENANCE AND REPAIRS OF THE MACHINE



**Observe the safety instructions and regulations for maintenance and treatment.**

- Check that all screws and other assembly points are tight **before each use of the machine** and whenever needed.
- Regularly check the prescribed pressure in tyres of the machine and the condition of the tyres. Repair the tyres in a professional workshop.
- Regularly check the wear and tear of the working parts of the machine. The quality of work decreases with the worn working parts.
- Lubricate all indicated lubrication places according to Chapter 6.1. The machine is fully equipped with flat eraser heads according to DIN 3404.
- Replace shares according to Chapter 6.3.
- Adjusting, cleaning and lubricating the machine may only be performed when the machine is standing still, i.e. the machine is stopped and is not working.
- When adjusting, cleaning, maintaining and repairing the machine, secure the folding and rotary parts of the machine that could put the operator in danger by fall or other movement.
- When repairing the unfolded machine parts, use a suitable support device leaning against labelled places or appropriate places.
- For attaching the machine when manipulating it with the use of lifting equipment, use only places marked by stick-on labels with the symbol of a chain “”.
- If there is a defect or damage on the machine, immediately turn off the tractor engine and secure the engine from turning on, secure the set and the machine against movement ⇒ then you can remove the defect.
- When repairing the machine, use only original spare parts, suitable tools and protective equipment.
- Order original spare parts according to the Spare Parts Catalogue.
- If you have to weld during the repair and have the machine attached to the tractor at the same time, the supply cables have to be disconnected from the alternator and accumulator.
- Keep the machine clean.



**Do not use a high-pressure cleaner or direct water jet for cleaning bearings. The bearings are not waterproof under high pressure.**

### 6.1 LUBRICATION PLAN FOR THE MACHINE

Regular lubrication of lubricating places increases the usable life of the nodes and the machine. Perform lubrication according to the “Lubrication Plan”.

When lubricating the bearings of the rollers, observe caution so that you do not damage the bearings. When lubricating the bearings of the rollers, turn the roller around so that the lubricant spreads evenly.

Lubricate the nodes until clean lubricant is coming out of them. Then wipe the lubricant off.

Chart 3 – Places and intervals of lubrication

PLACE FOR LUBRICATION		INTERVAL *	LUBRICANT
Controlling handle	Picture 10	once week*	Plastic lubricant K EP2 - 30 DIN 51 502

\*- valid for periods when the machine is used for work in the field

Picture 10 – Lubricating the controlling handle

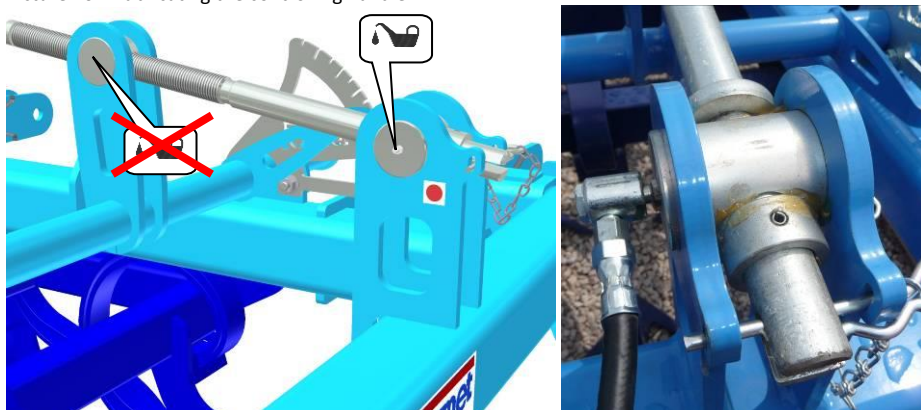

### **MANIPULATION WITH LUBRICANTS:**

- Treat oils and lubricants as hazardous waste according to valid regulations and acts.
- Protect yourself from direct contact with oils by using gloves or protective lotion.
- Wash oil stains on skin thoroughly with warm water and soap. Do not clean the skin with petrol, diesel oil or other dissolving agents.
- Oil or lubricant is poisonous. If you swallow any, immediately seek a doctor.
  - Keep oil and lubricants out of reach of children.



### **6.2 REPLACEMENT OF WORN SHARES**

- Always observe the safety regulations and instructions when replacing shares.
- When replacing the ploughshares, the machine must be aggregated with the tractor and put into the transport position according to Chapter 3.1/p.13.
- The tractor must be turned off and the operator or repairer must prevent free access of unauthorized persons to the tractor.
- The operator shall secure the machine against a potential fall by a MECHANICAL SUPPORT.
- Replace the shares on solid and even surface and when the machine is standing still.

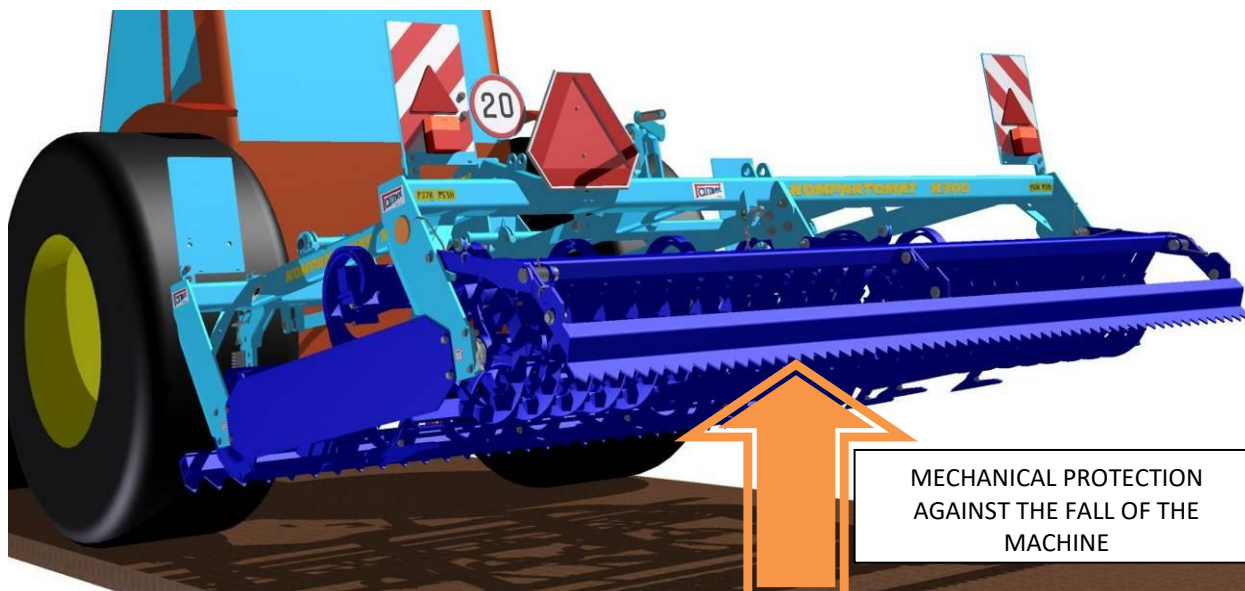

## 7. EXTRA MACHINE EQUIPMENT

- The machine construction may be fitted with extra equipment that will increase the comfort of operating the machine and also the usable properties of the machine
- When using the machine with extra equipment, always observe the safety regulations
- The extra equipment is designed to be used on the Farmet Kompaktomat machines

### 7.1 HYDRAULIC LEVELLERS = continuous control of the front leveller height from the driver's position (Chapter 5.1)

- This equipment allows continuously changing the height of the front leveller by controlling the hydraulic circuit from the tractor driver's position, i.e. the position does not have to stop and adjust the height manually.

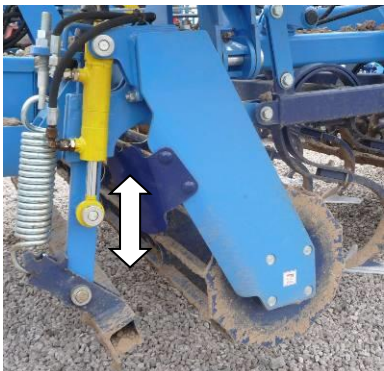

Requirement for the hydraulic system of the tractor	- Independent circuit for the adjustment of the leveller height	<b>Pressure in the circuit 200bar, 2 sockets for snap coupling ISO 12.5</b>
---	---	---

### 7.2 HYDRAULIC DEPTH = continuous control of the depth of the ploughshares from the driver's position (Chapter 5.2)

- This equipment allows continuously changing the depth of the ploughshares by controlling the hydraulic circuit from the tractor driver's position, i.e. the position does not have to stop and adjust the height manually.



Requirement for the hydraulic system of the tractor	- Independent circuit for the adjustment of the ploughshare depth	<b>Pressure in the circuit 200bar, 2 sockets for snap coupling ISO 12.5</b>
---	---	---

### 7.3 TRAIL CULTIVATORS FOR CARRIED KOMPAKTOMAT

- The construction of the carried machine does not allow placing the trail cultivators directly on the machine. Therefore, it is possible to attach an additional frame with the **TRAIL CULTIVATORS** between the tractor and the carried machine. The construction of the trail cultivators is attached to Kompaktomat through the three-point suspension. This set can then be aggregated with the tractor according to Chapter **3.1**.

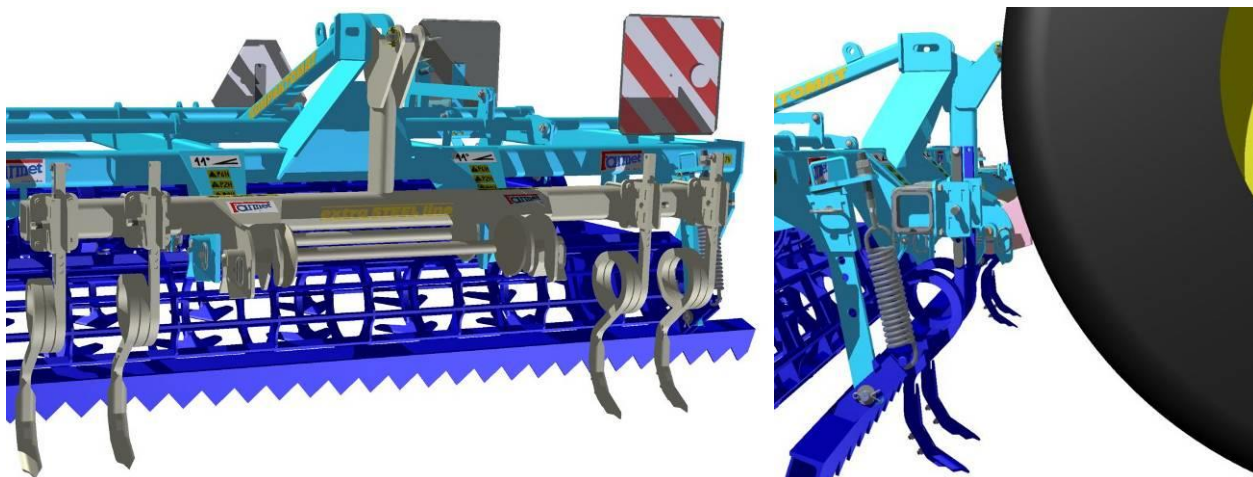

## **8. DISPOSAL OF THE MACHINE AFTER THE END OF ITS USABLE LIFE**

- The operator must make sure that the steel parts and parts in which the hydraulic oil or lubricant is used are separated for disposal.
- The operator will cut the steel parts according to safety regulations and hand them over to the scrap yard for secondary raw materials. For other parts follow the valid acts on wastes.

## **9. SERVICES AND WARRANTY CONDITIONS**

### **9.1 SERVICES**

After-sale service is ensured by the sales representative after consultation with the manufacturer or directly by the manufacturer. Spare parts are supplied by individual sellers via the nationwide sales network. Spare parts should be ordered according to the official spare-part catalogue issued by the manufacturer.

### **9.2 WARRANTY**

- 9.2.1 The manufacturer gives a 24-month warranty for the following machine parts: The main frame, the axle and the shaft (tow bar). The warranty period for the other parts of the machine is 12 months. The warranty period starts on the date of sale of a new machine to the end user.
- 9.2.2 The warranty applies to hidden defects that become evident within the warranty period provided that the machine has been properly used and maintained according to the Operating manual.
- 9.2.3 The warranty does not apply to common mechanical wear and tear of the exchangeable parts (e.g. shares, blades etc.)
- 9.2.4 The warranty does not apply to indirect consequences (such as a lower service life, etc.) resulting from a possible damage.
- 9.2.5 The warranty is engaged on the particular machine and does not become extinct with changing the owner.
- 9.2.6 The warranty is limited to dismantling and assembling or possibly to replacement or repair to the given defective part. The decision on replacing or repairing the defective part is the sole responsibility of the workshop authorized by Farmet.
- 9.2.7 For the time of the warranty period, only an authorised servicing technician of the producer may perform repairs or other interventions into the machine. Otherwise the warranty will not be acknowledged. This provision does not apply to the replacement of wearable spare parts (see point 9.2.3).
- 9.2.8 The warranty is conditioned by using original spare parts of the manufacturer.

(CZ) ES PROHLÁŠENÍ O SHODĚ  
 (GB) CE CERTIFICATE OF CONFORMITY  
 (D) EG-KONFORMITÄTSEKTLÄRUNG  
 (F) DÉCLARATION CE DE CONFORMITÉ  
 (RU) СЕРТИФИКАТ СООТВЕТСТВИЯ ЕС  
 (PL) DEKLARACJA ZGODNOŚCI WE

1. (CZ) My (GB) We (D) Wir (F) Nous (RU) Мы (PL) My: **Farmet a.s.**  
 Jiřinková 276  
 552 03 Česká Skalice  
 Czech Republic  
 DIČ: CZ46504931  
 Tel/Fax: 00420 491 450136

(CZ) Vydáváme na vlastní zodpovědnost toto prohlášení. (GB) Hereby issue, on our responsibility, this Certificate. (D) Geben in alleiniger Verantwortung folgende Erklärung ab. (F) Publiions sous notre propre responsabilité la déclaration suivante. (RU) Под свою ответственность выдаем настоящий сертификат. (PL) Wydajemy na własną odpowiedzialność niniejszą Deklarację Zgodności.

2. (CZ) Strojní zařízení: - název : **Nesený kompaktomat**  
 (GB) Machine: - name : **Mounted Kompaktomat**  
 (D) Fabrikat: - Bezeichnung : **Anbaugeräte Kompaktomat**  
 (F) Machinerie: - dénomination : **Compactomats de portage**  
 (RU) Сельскохозяйственная машина: - наименование : **Навесной компактомат**  
 (PL) Urządzenie maszynowe: - nazwa : **Zawieszony Kompaktomat**

- typ, type : **K 300 N**  
 - model, modèle : **K 300 N I., K 300 N II.**  
 - (CZ) výrobní číslo :   
 - (GB) serial number  
 - (D) Fabriknummer  
 - (F) n° de production  
 - (RU) заводской номер  
 - (PL) numer produkcyjny:

3. (CZ) Příslušná nařízení vlády: č.176/2008 Sb. (směrnice 2006/42/ES). (GB) Applicable Governmental Decrees and Orders: No.176/2008 Sb. (Directive 2006/42/ES). (D) Einschlägige Regierungsverordnungen (NV): Nr.176/2008 Slg. (Richtlinie 2006/42/ES). (F) Décrets respectifs du gouvernement: n°.176/2008 du Code (directive 2006/42/CE). (RU) Соответствующие постановления правительства: № 176/2008 Сб. (инструкция 2006/42/ES). (PL) Odpowiednie rozporządzenia rządowe: nr 176/2008 Dz.U. (Dyrektywa 2006/42/WE).

4. (CZ) Normy s nimiž byla posouzena shoda: (GB) Standards used for consideration of conformity: (D) Das Produkt wurde gefertigt in Übereinstimmung mit folgenden Normen: (F) Normes avec lesquelles la conformité a été évaluée: (RU) Normы, на основании которых производилась сертификация: (PL) Normy, według których została przeprowadzona ocena: ČSN EN ISO 12100, ČSN EN ISO 4254-1.

(CZ) Schválil (GB) Approve by dne: 01.06.2012  
 (D) Bewilligen (F) Approuvé  
 (RU) Утвердил (PL) Uchwalit

p. Gavlas Dušan  
 technický ředitel  
 Technical director

  
**Farmet a.s.**  
 Jiřinková 276  
 552 03 Česká Skalice  
 DIČ CZ46504931  
 38

V České Skalici dne: 01.06.2012

Ing. Karel Žďárský  
 generální ředitel společnosti  
 General Manager



(CZ) ES PROHLÁŠENÍ O SHODĚ  
 (GB) CE CERTIFICATE OF CONFORMITY  
 (D) EG-KONFORMITÄTSEKTLÄRUNG  
 (F) DÉCLARATION CE DE CONFORMITÉ  
 (RU) СЕРТИФИКАТ СООТВЕТСТВИЯ ЕС  
 (PL) DEKLARACJA ZGODNOŚCI WE

1. (CZ) My (GB) We (D) Wir (F) Nous (RU) Мы (PL) My: **Farmet a.s.**  
 Jiřinková 276  
 552 03 Česká Skalice  
 Czech Republic  
 DIČ: CZ46504931  
 Tel/Fax: 00420 491 450136

(CZ) Vydáváme na vlastní zodpovědnost toto prohlášení. (GB) Hereby issue, on our responsibility, this Certificate. (D) Geben in alleiniger Verantwortung folgende Erklärung ab. (F) Publiions sous notre propre responsabilité la déclaration suivante. (RU) Под свою ответственность выдаем настоящий сертификат. (PL) Wydajemy na własną odpowiedzialność niniejszą Deklarację Zgodności.

2. (CZ) Strojní zařízení: - název : **Nesený kompaktomat**  
 (GB) Machine: - name : **Mounted Kompaktomat**  
 (D) Fabrikat: - Bezeichnung : **Anbaugeräte Kompaktomat**  
 (F) Machinerie: - dénomination : **Compactomats de portage**  
 (RU) Сельскохозяйственная машина: - наименование : **Навесной компактомат**  
 (PL) Urządzenie maszynowe: - nazwa : **Zawieszony Kompaktomat**

- typ, type : **K 250 N**  
 - model, modèle : **K 250 N I., K 250 N II.**  
 - (CZ) výrobní číslo :   
 - (GB) serial number  
 - (D) Fabriknummer  
 - (F) n° de production  
 - (RU) заводской номер  
 - (PL) numer produkcyjny:

3. (CZ) Příslušná nařízení vlády: č.176/2008 Sb. (směrnice 2006/42/ES). (GB) Applicable Governmental Decrees and Orders: No.176/2008 Sb. (Directive 2006/42/ES). (D) Einschlägige Regierungsverordnungen (NV): Nr.176/2008 Slg. (Richtlinie 2006/42/ES). (F) Décrets respectifs du gouvernement: n°.176/2008 du Code (directive 2006/42/CE). (RU) Соответствующие постановления правительства: № 176/2008 Сб. (инструкция 2006/42/ES). (PL) Odpowiednie rozporządzenia rządowe: nr 176/2008 Dz.U. (Dyrektywa 2006/42/WE).

4. (CZ) Normy s nimiž byla posouzena shoda: (GB) Standards used for consideration of conformity: (D) Das Produkt wurde gefertigt in Übereinstimmung mit folgenden Normen: (F) Normes avec lesquelles la conformité a été évaluée: (RU) Normы, на основании которых производилась сертификация: (PL) Normy, według których została przeprowadzona ocena: ČSN EN ISO 12100, ČSN EN ISO 4254-1.

(CZ) Schválil (GB) Approve by dne: 01.06.2012  
 (D) Bewilligen (F) Approuvé  
 (RU) Утвердил (PL) Uchwalit

p. Gavlas Dušan  
 technický ředitel  
 Technical director

  
**Farmet a.s.**  
 Jiřinková 276  
 552 03 Česká Skalice  
 DIČ CZ46504931  
 3P

V České Skalici dne: 01.06.2012

Ing. Karel Žďárský  
 generální ředitel společnosti  
 General Manager

